

Solenoid directional valves type SDHI

direct operated, ISO 4401 size 06

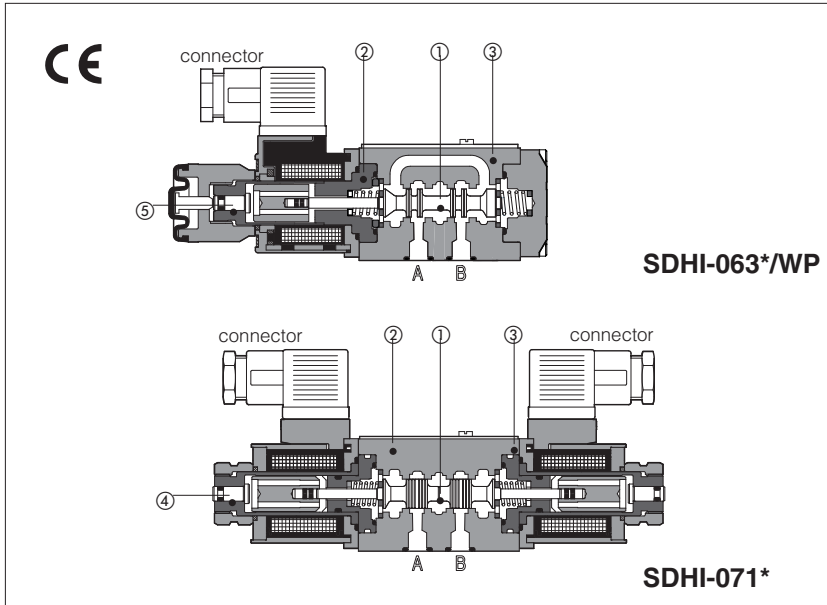

Spool type, two or three position, direct operated valves with solenoids certified according the North American standard **cURus**.

Solenoids ② are made by:

- wet type flanged tube, same for AC and DC power supply, with integrated manual override pin ④
- interchangeable coils, specific for AC or DC power supply, easily replaceable without tools - see section 5 for available voltages

Standard coils protection **IP65**, optional coils with IP67 AMP Junior Timer , XK Deutsch or Lead Wire connections.

Wide range of interchangeable spools ①, see section 2

The valve body ③ is 3 chamber type made by shell-moulding casting with wide internal passages.

Mounting surface: **ISO 4401 size 06**

Max flow: **60 l/min**

Max pressure: **350 bar**

1 MODEL CODE

SDHI - 0	61	1	/A - X	24 DC	**	/*
Directional control valves size 06						Seals material, see section 3:
Valve configuration, see section 2						- = NBR
61 = single solenoid, center plus external position, spring centered						PE = FKM
63 = single solenoid, 2 external positions, spring offset						BT = HNBR
67 = single solenoid, center plus external position, spring offset						
70 = double solenoid, 2 external positions, without springs						
71 = double solenoid, 3 positions, spring centered						
75 = double solenoid, 2 external positions, with detent						
77 = double solenoid, center plus external position, without springs						
Spool type, see section 2						
Options, see note 1 at section 4						

00 = valve without coils
 X = without connector
 See section 4 for available connectors, to be ordered separately
 Coils with special connectors, see section 4
 XJ = AMP Junior Timer connector
 XK = Deutsch connector
 XS = Lead Wire connection

2 CONFIGURATIONS and SPOOLS (representation according to ISO 1219-1)

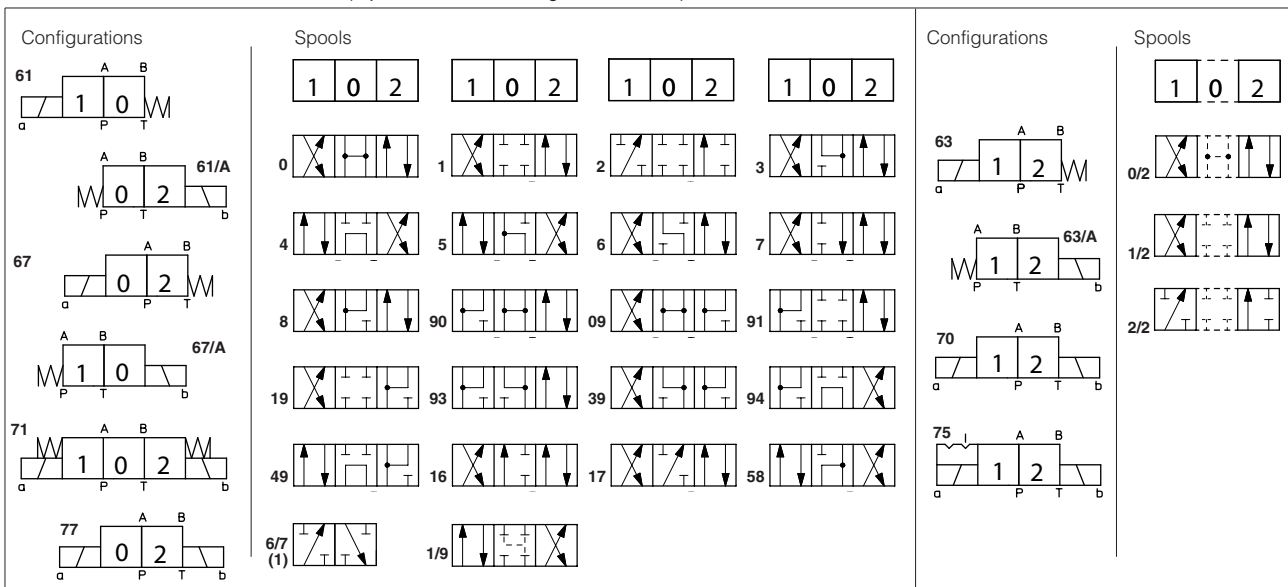

Note: see also section 4, note 3, for special shaped spools

(1): spool type 6/7 available only for configuration 61, not available for version /A

3 MAIN CHARACTERISTICS, SEALS AND HYDRAULIC FLUID - for other fluids not included in below table, consult our technical office

Assembly position / location	Any position for all valves except for type - 70 and 77 (without springs) that must be installed with horizontal axis if operated by impulses		
Subplate surface finishing	Roughness index Ra 0,4 - flatness ratio 0,01/100 (ISO 1101)		
MTTFd values according to EN ISO 13849	150 years, for further details see technical table P007		
Ambient temperature	Standard execution = -30°C ÷ +70°C; /PE option = -20°C ÷ +70°C; /BT option = -40°C ÷ +70°C		
Seals, recommended fluid temperature	NBR seals (standard) = -20°C ÷ +60°C, with HFC hydraulic fluids = -20°C ÷ +50°C FKM seals (/PE option) = -20°C ÷ +80°C HNBR seals (/BT option) = -40°C ÷ +60°C, with HFC hydraulic fluids = -40°C ÷ +50°C		
Recommended viscosity	15 ÷ 100 mm ² /s - max allowed range 2.8 ÷ 500 mm ² /s		
Fluid contamination class	ISO 4406 class 21/19/16 NAS 1638 class 10, in line filters of 25 µm (β10 ≥75 recommended)		
Hydraulic fluid	Suitable seals type	Classification	Ref. Standard
Mineral oils	NBR, FKM, HNBR	HL, HLP, HLPD, HVLP, HVLDP	DIN 51524
Flame resistant without water	FKM	HFDU, HFDR	ISO 12922
Flame resistant with water	NBR, HNBR	HFC	
Flow direction	As shown in the symbols of table 2		
Operating pressure	Ports P,A,B: 350 bar ; Port T 120 bar		
Rated flow	See diagrams Q/Δp at section 6		
Maximum flow	60 l/min , see operating limits at section 7		

3.1 Coils characteristics

Insulation class	H (180°C) Due to the occurring surface temperatures of the solenoid coils, the European standards EN ISO 13732-1 and EN ISO 4413 must be taken into account
Protection degree DIN EN 60529	IP 65 (with connectors 666, 667, 669 or E-SD correctly assembled)
Relative duty factor	100%
Supply voltage and frequency	See electric feature 6
Supply voltage tolerance	± 10%
Certification	cURus

4 NOTES

1 Options

- A** = Solenoid mounted at side of port B (only for single solenoid valves). In standard versions, solenoid is mounted at side of port A.
WP = prolonged manual override protected by rubber cap - see section 11.



The manual override operation can be possible only if the pressure at T port is lower than 50 bar - see section 11.

WPD/H = manual override with detent, to be ordered separately, see tab. K150

FI, FV = with proximity or inductive position switch for monitoring spool position: see tab. E110.

MV, MO = auxiliary hand lever positioned vertically (MV) or horizontally (MO). For available configuration and dimensions see table E138.

2 Type of electric/electronic connector DIN 43650, to be ordered separately

666 = standard connector IP-65, suitable for direct connection to electric supply source.

667 = as 666, but with built-in signal led.

669 = with built-in rectifier bridge for supplying DC coils by alternate current (AC 110V and 230V - I_{max} 1A).

E-SD = electronic connector which eliminates electric disturbances when solenoid valves are de-energized.

3 Special shaped spools

- spools type **0** and **3** are also available as **0/1** and **3/1** with restricted oil passages in central position, from user ports to tank.
- spools type **1, 4, 5** and **58** are also available as **1/1, 4/8, 5/1** and **58/1**. They are properly shaped to reduce water-hammer shocks during the swiching.
- spools type **1, 3, 8** and **1/2** are available as **1P, 3P, 8P** and **1/2P** to limit valve internal leakages.
- spool type **1/9** has closed center in rest position but it avoids the pressurization of A and B ports due to the internal leakages.
- Other types of spools can be supplied on request.

5 ELECTRIC FEATURES

External supply nominal voltage ± 10%	Voltage code	Type of connector	Power consumption (2)	Code of spare coil	Colour of coil label		
				DHI			
6 DC	6 DC	666 or 667	33 W	COU-6DC / 80	brown		
9 DC	9 DC			COU-9DC / 80	light blue		
12 DC	12 DC			COU-12DC / 80	green		
14 DC	14 DC			COU-14DC / 80	brown		
18 DC	18 DC			COU-18DC / 80	blue		
24 DC	24 DC			COU-24DC / 80	red		
28 DC	28 DC			COU-28DC / 80	silver		
48 DC	48 DC			COU-48DC / 80	silver		
110 DC	110 DC			COU-110DC / 80	black		
125 DC	125 DC			COU-125DC / 80	silver		
220 DC	220 DC			COU-220DC / 80	black		
24/50 AC 24/60 AC	24/50/60 AC			669	60 VA (3)	COI-24/50/60AC / 80 (1)	pink
48/50 AC 48/60 AC	48/50/60 AC					COI-48/50/60AC / 80 (1)	white
110/50 AC 120/60 AC	110/50/60 AC 120/60 AC					COI-110/50/60AC / 80 (1) COI-120/60AC / 80	yellow white
230/50 AC 230/60 AC	230/50/60 AC 230/60 AC	COI-230/50/60AC / 80 (1) COI-230/60AC / 80	light blue silver				
110/50 AC 120/60 AC	110RC	33 W	COU-110RC / 80			gold	
230/50 AC 230/60 AC	230RC		COU-230RC / 80			blue	

(1) Coil can be supplied also with 60 Hz of voltage frequency: in this case the performances are reduced by 10 ÷ 15% and the power consumption is 55 VA.

(2) Average values based on tests preformed at nominal hydraulic condition and ambient/coil temperature of 20°C.

(3) When solenoid is energized, the inrush current is approx 3 times the holding current. Inrush current values correspond to a power consumption of about 150 VA.

6 Q/ΔP DIAGRAMS based on mineral oil ISO VG 46 at 50°C

Flow direction Spool type	P→A	P→B	A→T	B→T	P→T
	0, 0/1	C	C	C	C
0/2, 1, 1/1, 1/2, 1/9	A	A	A	A	
2, 3, 3/1	A	A	C	C	
2/2, 4, 4/8, 5, 5/1, 58, 58/1, 94	D	D	D	D	A
6, 7, 16, 17	A	A	C	A	
8	C	C	B	B	
9, 19, 90, 91	B	B	A	A	
39, 93	D	D	D	D	

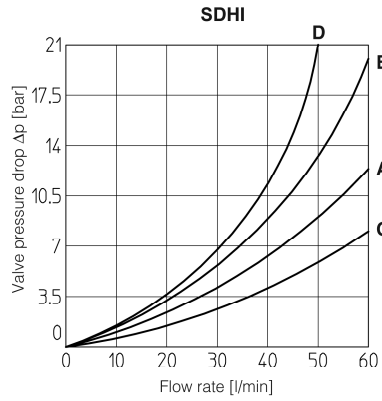

7 OPERATING LIMITS based on mineral oil ISO VG 46 at 50°C

The diagrams have been obtained with warm solenoids and power supply at lowest value ($V_{nom} = 10\%$). The curves refer to application with symmetrical flow through the valve (i.e. P→A and B→T). In case of asymmetric flow and if the valves have the devices for controlling the switching times the operating limits must be reduced.

SDHI

Curve	Spool type
A	0, 1, 1/2, 8
B	0, 0/1, 0/2, 1/1, 1/9, 3, 3/1
C	4, 4/8, 5, 5/1, 6, 7, 16, 17, 19, 39, 49, 58, 58/1, 09, 90, 91, 93, 94
D	2, 2/2

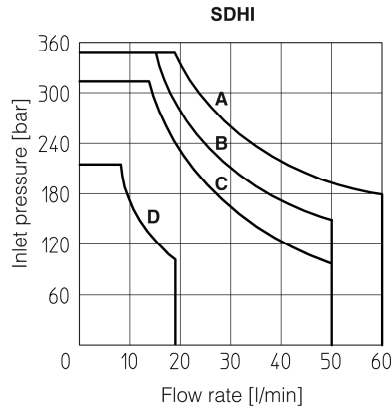

8 SWITCHING TIMES (average values in msec)

Valve	Switch-on AC	Switch-on DC	Switch-off
SDHI + 666 / 667	30	45	20
SDHI + 669	45	—	80
SDHI + E-SD	30	45	50

Test conditions:

- 36 l/min; 150 bar
- nominal voltage
- 2 bar of counter pressure on port T
- mineral oil: ISO VG 46 at 50°C.

The elasticity of the hydraulic circuit and the variations of the hydraulic characteristics and temperature affect the response time.

9 SWITCHING FREQUENCY

Valve	AC (cycles/h)	DC (cycles/h)
DHI + 666 / 667	7200	15000

10 COILS WITH SPECIAL CONNECTORS only for voltage supply 12, 14, 24, 28 VDC

AMP Junior timer connector	Deutsch connector DT-04-2P	Lead Wire connection
<p>Options -XJ Coil type COUJ, AMP Junior Timer connector Protection degree IP67</p>	<p>Options -XK Coil type COUK Deutsch connector DT-04-2P male Protection degree IP67</p>	<p>Options -XS Coil type COUS, Lead Wire connection Cable length = 180 mm</p>

Note: For the electric characteristics refer to standard coils features - see section 5

11 DIMENSIONS [mm]

ISO 4401: 2005

Mounting surface: 4401-03-02-0-05

Fastening bolts:

4 socket head screws M5x50 class 12.9

Tightening torque = 8 Nm

Seals: 4 OR 108

Ports P,A,B,T: $\varnothing = 7.5$ mm (max).

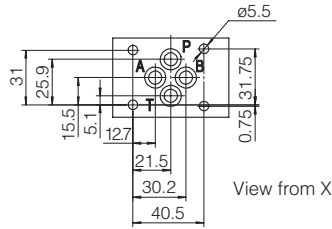

P = PRESSURE PORT
A, B = USE PORT
T = TANK PORT

OPTION /WP

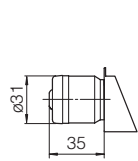

SDHI-06

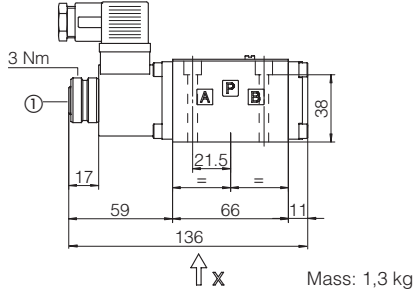

SDHI-07

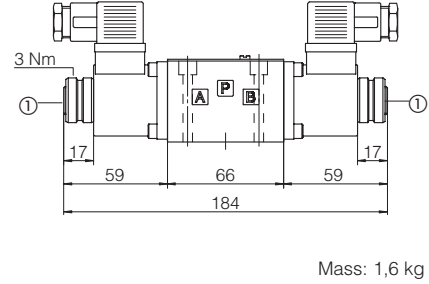

① Standard manual override PIN

⚠ The manual override operation can be possible only if the pressure at T ports is lower than 50 bar

Overall dimensions refer to valves with connectors type 666

12 PLUG-IN RESTRICTOR (to be ordered separately)

The use of plug-in restrictors in valve's ports P or A or B may be necessary in case of particular conditions as long flexible hoses or the presence of accumulators which could cause at the valve switching instantaneous high flow peaks over the max valve's operating limits.

Ordering code:

PLUG H

08, 10, 12, 15 calibrated orifice diameter in tenths of mm

Example PLUG-H-12 = orifice diameter **1,2 mm**

Other orifice dimensions are available on request

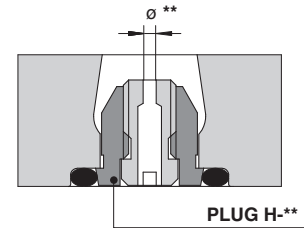

13 ELECTRIC CONNECTORS ACCORDING TO DIN 43650 (to be ordered separately)

666, 667 (for AC or DC supply)		669 (for AC supply)		CONNECTOR WIRING		
				666, 667 1 = Positive ⊕ 2 = Negative ⊖ ⊕ = Coil ground		669 1,2 = Supply voltage V _{AC} 3 = Coil ground
SUPPLY VOLTAGES						
666 All voltages		667 24 AC or DC 110 AC or DC 220 AC or DC		669 110/50 AC 110/60 AC 230/50 AC 230/60 AC		

Note: for electronic connectors type **E-SD**, see tab. K500

14 MOUNTING SUBPLATES

Model	Ports location	GAS Ports A-B-P-T	Ø Counterbore [mm] A-B-P-T	Mass [kg]
BA-202	Ports A, B, P, T underneath;	3/8"	–	1,2
BA-204	Ports P, T underneath; ports A, B on lateral side	3/8"	25,5	1,8
BA-302	Ports A, B, P, T underneath	1/2"	30	1,8

The subplates are supplied with 4 fastening bolts M5x50. Also available are multi-station subplates and modular subplates. For further details see table K280.